

Bedienungsanleitung FAVORIT

Указание за монтаж	(BG)	Techninės priežiūros instrukcija	(LT)
Návod k obsluze	(CZ)	Tehniskās apkalpošanas instrukcija	(LV)
Betjeningsvejledning	(DK)	Gebruiksaanwijzing	(NL)
Manual de instrucciones	(E)	Instrukcja obsługi	(PL)
Hooldusjuhend	(EST)	Instrucțiuni de montaj	(RO)
Instructions d'utilisation	(F)	Инструкция по обслуживанию	(RUS)
Operating Instructions	(GB)	Bruksanvisning	(S)
Οδηγίες τοποθέτησης	(GR)	Käyttöohjeet	(SF)
Kezelési utasítás	(H)	Návod k obsluhu	(SK)
Uputstvo za rukovanje	(HR)	Kullanma talimatı	(TR)
Istruzioni per l'uso	(I)	Упутство за руковање	(YU)

Druckstand: 03.10/SF/10

05086_3_07.03/1

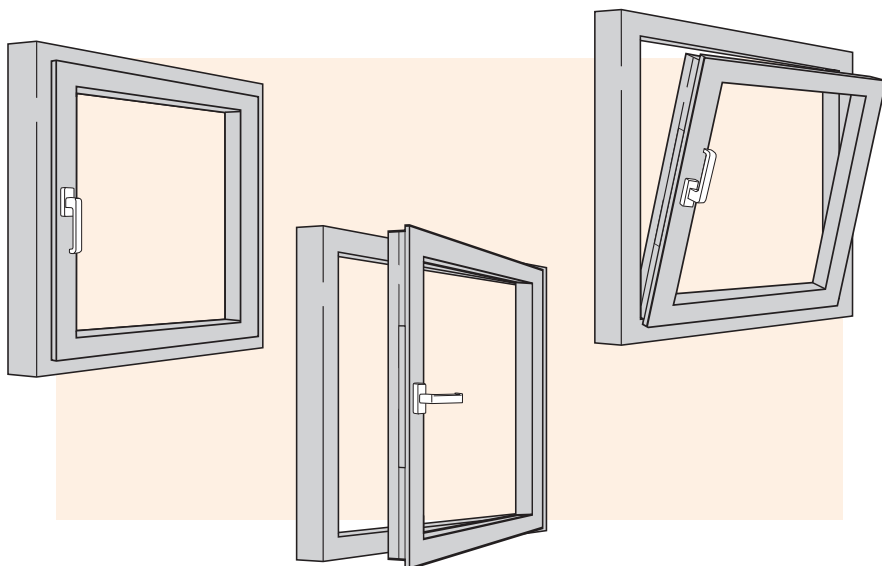

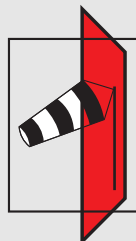
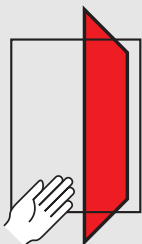
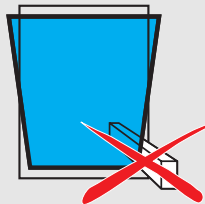
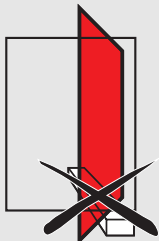
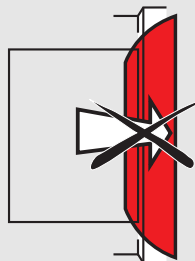
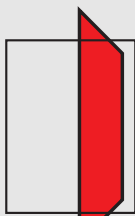

 **Warnung!**

(D)

**Verletzungsgefahr
bei Funktionsstörung!**

Das Fenster **nicht** weiter betätigen,
sondern **sichern** und umgehend von
einem Fensterfachbetrieb instandsetzen
lassen.

 **Upozornění!**

(CZ)

**Při poruchách funkce kování je
nebezpečí poranění!**

Okno proto dále nepoužívejte, nýbrž jej
zabezpečte a neprodleně nechte opravit
odbornou firmou.

 **¡Atención!**

(E)

**¡Riesgo de lesiones por
interrupción del funcionamiento!**

No seguir manipulando la ventana, sino
asegurarla y repararla enseguida por un
experto.

 **Attention!**

(F)

**Danger d'accident lors de
dysfonctionnement!**

Ne pas continuer à utiliser la fenêtre,
mais la **condamner** et la faire remettre
en état par un menuisier.

 **Προσοχή!**

(GR)

**Κίνδυνος τραυματισμού εν ώρα
διακοπής λειτουργίας!**

Μην κινείτε άλλο το παραθύρο, αλλά
ασφαλίστε το και ειδοποιήστε άμεσα τον
κατασκευαστή σας για να διορθωθεί η
βλάβη.

 **Pozor!**

(HR)

**Opasnost od povreda pri smetnji
u funkcionisanju!**

Ne rukovati dalje sa prozorom, nego
poduzeti sigurnosne mjere i zbog
popravke odmah izvijestiti stručno osoblje.

 **Внимание!**

(BG)

**Опасност от нараняване при
проблем с функционирането на
механизма!**

Не се опитвайте да раздвижвате
крилото, а го **подсигурете** и се
обърнете своевременно за помощ към
специализирана фирма за дограма.

 **Advarsel!**

(DK)

**Risiko for personskade
ved funktionsfejl!**

Forsøg **ikke** at åbne/lukke vinduet.
Sørg i stedet for at **afsikre** vinduet og
tilkald fagmand for omgående reparation.

 **Tähelepanu!**

(EST)

**Kui ilmnevad funktsionaalsed
defektid, nad võivad kujutada ohtu
teie turvalisusele!**

Sel puhul lükandelement mitte
kasutada ja koheselt kinnitada ta
eelnevas asendis. Parandus töid võivad
teha ainult spetsialistid.

 **Warning!**

(GB)

Malfunction carries a risk of injury!

Do **not** continue to operate the window,
but make it **safe** and have it repaired
immediately by a specialist window
company.

 **Figyelem!**

(H)

**A nem megfelelő használat esetén
sérülés veszélye áll fenn!**

Kérjük, ne használja tovább az ablakot,
hanem biztosítsa ki, és azonnal forduljon
egy ablakgyártó céghez segítségért.

 **Attenzione!**

(I)

**Pericolo di lesioni in caso di guasto al
funzionamento!**

Non aprire la finestra, ma **bloccarla**
e farla riparare da un serramentista
specializzato.

 **DĒMESIO!**

(LT)

Esant funkcionavimo sutrikimams yra pavojus susižeisti!

Stumdomos dalies neekspluatuoti, bet sutvirtinti, ir nedelsiant iškviešti specializuotos firmos atstovą atlikti remonto darbų.

 **Opgepast!**

(NL)

Opgelet, gevaar voor verwonding bij functionele storing!

Het raam **niet** verder bedienen, maar **beveiligen** en onmiddellijk laten herstellen door een deskundig bedrijf.

 **Atenție!**

(RO)

Pericol de accidentare la defecțiune de funcționare!

Fereastra nu va mai fi folosită, iar în acest caz va fi aranjată într-o poziție de siguranță și se va monta conform normelor de către o firmă specializată în montarea ferestrelor.

 **Observera!**

(S)

Risk för personskada vid funktionsfel!

Försök inte att använda fönstret ytterligare, men säkra det, och låt det omgående repareras av en fönsterfackman.

 **Upozornenie!**

(SK)

Nebezpečnost poranenia pri narušení funkčnosti!

Nemanipulujte ďalej s oknom, ale ho zabezpečte a bezodkladne ho nechajte prekontrolovať odborníkovi.

 **Упозорење!**

(YU)

Опасност од повреда при сметњи у функционисању!

Не руковати даље са прозором, него предузети сигурносне мере и због поправке одмах известити стручно особље.

 **Attenzione!**

(LV)

Uzmanīgi, loga bojājuma defekta gadījuma iespējama savainošanas!

Ja traucēta loga funkcionēšana, griezties pie loga izgatavotāja.

 **Ostrzeżenie!**

(PL)

Uwaga! Grozi skałeczeniem!

W przypadku problemów z działaniem okna, okno należy natychmiast zabezpieczyć i zadzwonić po pracowników serwisu firmy, która wyprodukowała okna.

 **Предупреждение!**

(RUS)

Внимание, травмоопасно при наличии неисправности!

Прекратить дальнейшую эксплуатацию окна, принять меры предосторожности и немедленно обратиться к специалистам оконных предприятий для устранения неисправности.

 **Varoitus!**

(SF)

Rikkoontumisvaara toimintahäiriön sattuessa!

Jos ikkunan toiminnassa havaitaan häiriö, tulee sen käyttö lopettaa. Ikkunan korjauksessa ja kunnossapidossa tulee käyttää asiantuntijan apua.

 **Dikkat!**

(TR)

Fonksiyon probleminde yaralanma tehlikesi!

Pencereyi zorlamayın, emniyete alın ve hemen bir pencere üreticisinin onarmasını sağlayın.

